

Spectral Thermography

Special systems by InfraTec – ImageIR® and VarioCAM® hr head

Infrared thermography

Infrared thermography meanwhile is established as an efficient method for contact-free measurement of temperature distribution. In practice the ambitious task often occurs, to carry out exact measurements also of the surface temperature of materials with high transmission or reflection in the infrared spectral range. In addition, thermography also shall be applied to acquire temperature data of objects behind glass, flames, gas, etc. For the execution of thermographic measurements on such objects the exact knowledge of their spectral characteristics is of particular importance.

Spectral thermography

The spectral power distribution according to Planck's Radiation Law exists in theory only. In practice, measuring objects or materials are existing as „grey bodies“ or with an emissivity depending on the wavelength. Spectral thermography is detecting the infrared radiation in selected wavelength ranges, using those ranges with optimal emissivity – especially within the so-called absorption bands – or with a high transmissivity. For this purpose the MWIR range (2 ... 5) μm which contains many emissivity maxima of interesting materials is especially.

Equipment

Especially suitable for spectral thermography are the MWIR thermographic systems of the ImageIR®-series, offered by InfraTec. Equipped with a motorized filter wheel these camera systems allow – software-controlled - the insertion of different filter positions directly into the optical path of the detector. An alternative solution are manual filter slides – for example for the uncooled microbolometer camera VarioCAM® hr head – for on-glass measurements, protection against CO₂ – laser and measurements on plastic foils.

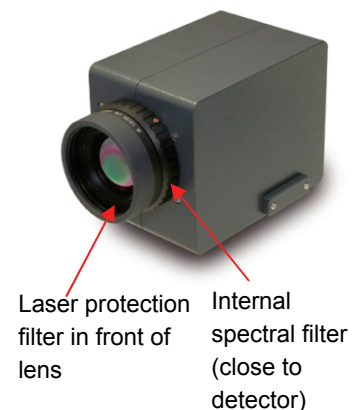
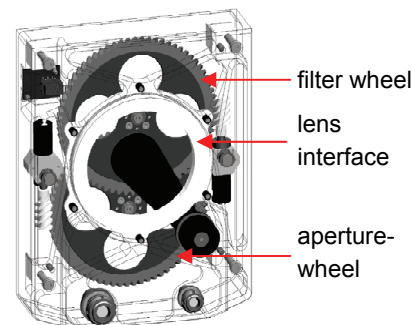
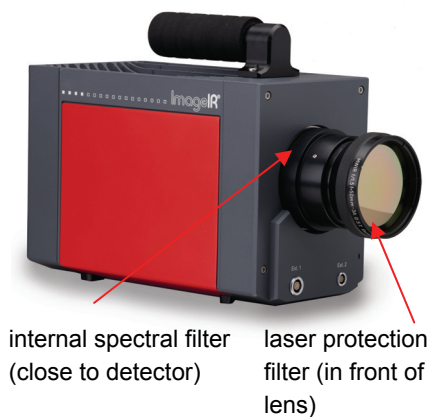

Fig. 1 High-end camera series ImageIR® with motorized filter wheel (4 positions)

Fig. 2 Opto-mechanism of ImageIR®

Fig. 3 VarioCAM® hr head with filter slide close to detector

Spectral Thermography

Special systems by InfraTec – ImageIR® and VarioCAM® hr head

Spectral filter

The use of spectral filters requires a special calibration of the thermographic system in the desired temperature range. Narrow-band filters are leading to a significantly lower response of the thermographic camera (worse signal/noise ratio), whereby the thermal resolution in lower temperature ranges can decrease. In spectral thermography so called longwave-pass filters (LWP), shortwave-pass filters (SWP), bandpass filters (BP) and narrow bandpass filters (NBP) are used.



Fig. 4: Spectral filters for thermographic cameras

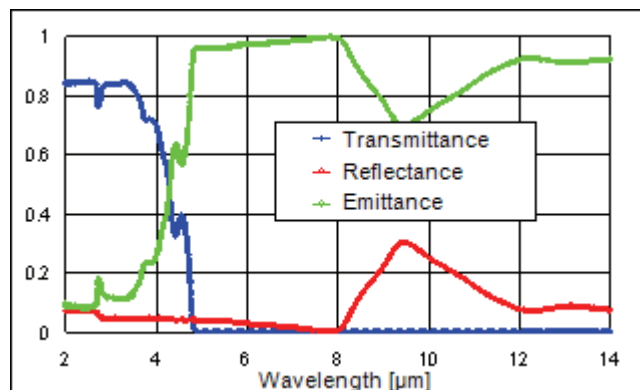

Fig. 5 Spectral transmissivity, reflectivity and emissivity of glass

Selection of some sensitivity ranges

Matter	Filter	Absorption band	Application examples
Glass (on glass)	LWP	5,3 µm	Temperature measurement on light bulbs
Through glass	BP	2,3 µm	Temperature measurement on lamp filaments
Flames (CO ₂)	BP	4,25 µm	Fire monitoring in power stations
Through flames	BP	3,9 µm	Temperature measurement in furnaces
Plastic foils	BP	3,4 µm	Temperature monitoring during film extrusion process
Through atmosphere	BP	(3,6 ... 4,1) µm	Reduction of the influence of water bands

Table 1: Selected spectral filters for ImageIR®

Spectral Thermography

Special systems by InfraTec – ImageIR® and VarioCAM® hr head

"On-glass" and "Through-glass" measurements (LWIR and MWIR)

The wavelength of **ImageIR®** of (2 ... 5) μm turns out to be especially convenient for measurements in glass and light bulb production, as it is possible to carry out temperature measurements with little reflection "on-glass" as well as "through-glass", according to the respective requirements. Therefore, the specific characteristics of glass in the wavelength range of above and below 4 μm are of use. Below 4 μm "through-glass" measurements can be realized very well because of the high transmissivity. Certainly the absorption of the material, which is going up with increasing thickness of the material above 2.8 μm , is to be considered while calculating the temperature. If, on the other hand, the short wave radiation is suspended well enough, using suitable LWP, there will be no more "through-glass" measurement and an accurate measurement of the surface temperature of glass, nearly without reflection, will be possible. The reflection of glass in the spectral range of (2 ... 5) μm is considerably lower than in the so called long wave range of (8 ... 12) μm . For this reason, the measurement result – depending on the environmental temperature – only is insignificantly influenced by reflection.

Optimized "on-glass" measurement can also be realized with **VarioCAM® hr head** working within the spectral range of (7.5 ... 14) μm . The camera must be equipped with filter slides (SWP 8.0 μm) for surface temperature measurements.

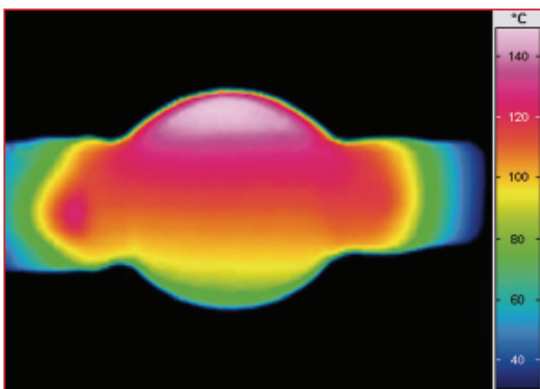

Fig. 6 Measurement with spectral filter "on-glass"

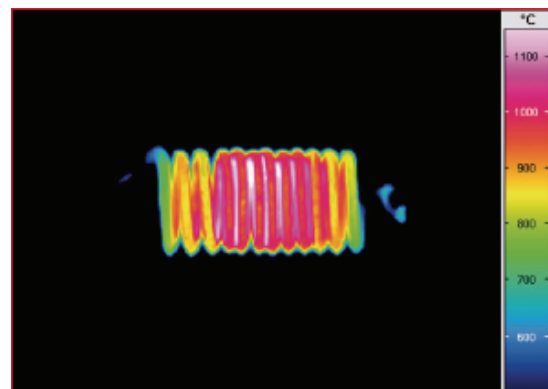

Fig. 7 Measurement with spectral filter "through-glass"

Other applications of spectral thermography

Besides the "on-glass" and "through-glass" measurement exists a number of other applications in different industrial sectors as well as in the field of research and development:

- **IR-reflectography (only MWIR)**

IR-reflectography is used for the detection of lower painting layers due to its spectral behaviour (upper layer transmissive, lower drawings reflective).

- **Humidity detection (only MWIR)**

With the help of humidity detection, for example for the analysis of building materials in case of claims, the spectral absorption factor of water band is defined.

Spectral Thermography

Special systems by InfraTec – ImageIR® and VarioCAM® hr head

- **Leakage (only MWIR)**

Another interesting application is the detection of leakages on tanks using IR-detectable gases. A suitable and available gas is CO₂, having a strong absorption band at 4,25 µm. A tempered background helps to recognize the leaving gas flow.

- **Temperature measurement of flames (only MWIR)**

Temperature of flames can be estimated by measuring selectively within the absorption band of CO₂ at 4.25 µm. Thermography at objects behind the flame is possible using the spectral range of (3.75 ... 4) µm (for example furnace walls or pipes).

- **Film extrusion process (LWIR und MWIR)**

Film surface temperature can be measured using a band pass filter at 3.4 µm (applicable for various plastics, e.g. polyethylene, polypropylene, polyamide, polyvinyl). For some plastics an absorption band at 8 µm (LWIR) can be used.

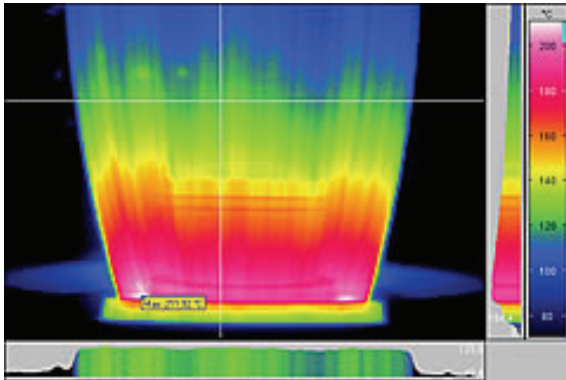

Fig. 8 Film surface temperature measurement (Extrusion)

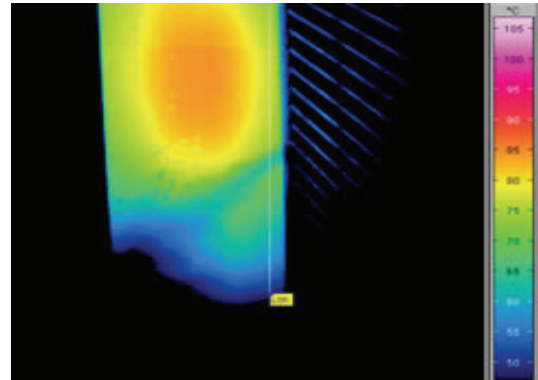

Fig. 9 CO₂ – gas flow on a car cooler